



**Shoring without tie back**



**Shoring with using tie back**



**Trench shoring with walings/struts**

## **Excavation shoring with timber wedge clamps**

The cost-effective alternative  
to traditional soldier pile walls  
(Berlin-type pit lining)

with tables for quick preliminary design

## Timber wedge clamp wall

The timber wedge clamp wall with timber planks attached to the front of each soldier pile is ideal for deep trenches and excavations on inner-city sites. The system consists of just three parts: wedge plate, U-plate and wedge. The timber wedge clamp saves time and materials:

- **No expensive excavation between the soldier piles**
  - Timber planks are simply placed in front
  - Timber planks fixed regardless of exact positions of soldier piles
- **No sawing, no cutting planks to size**
  - Long planks can be used
  - Planks can be used again and again
- **No settlement, no loss of soil**
  - Installation of two planks at a time helps maintain the stresses in the soil
  - Can also be dismantled from the bottom up

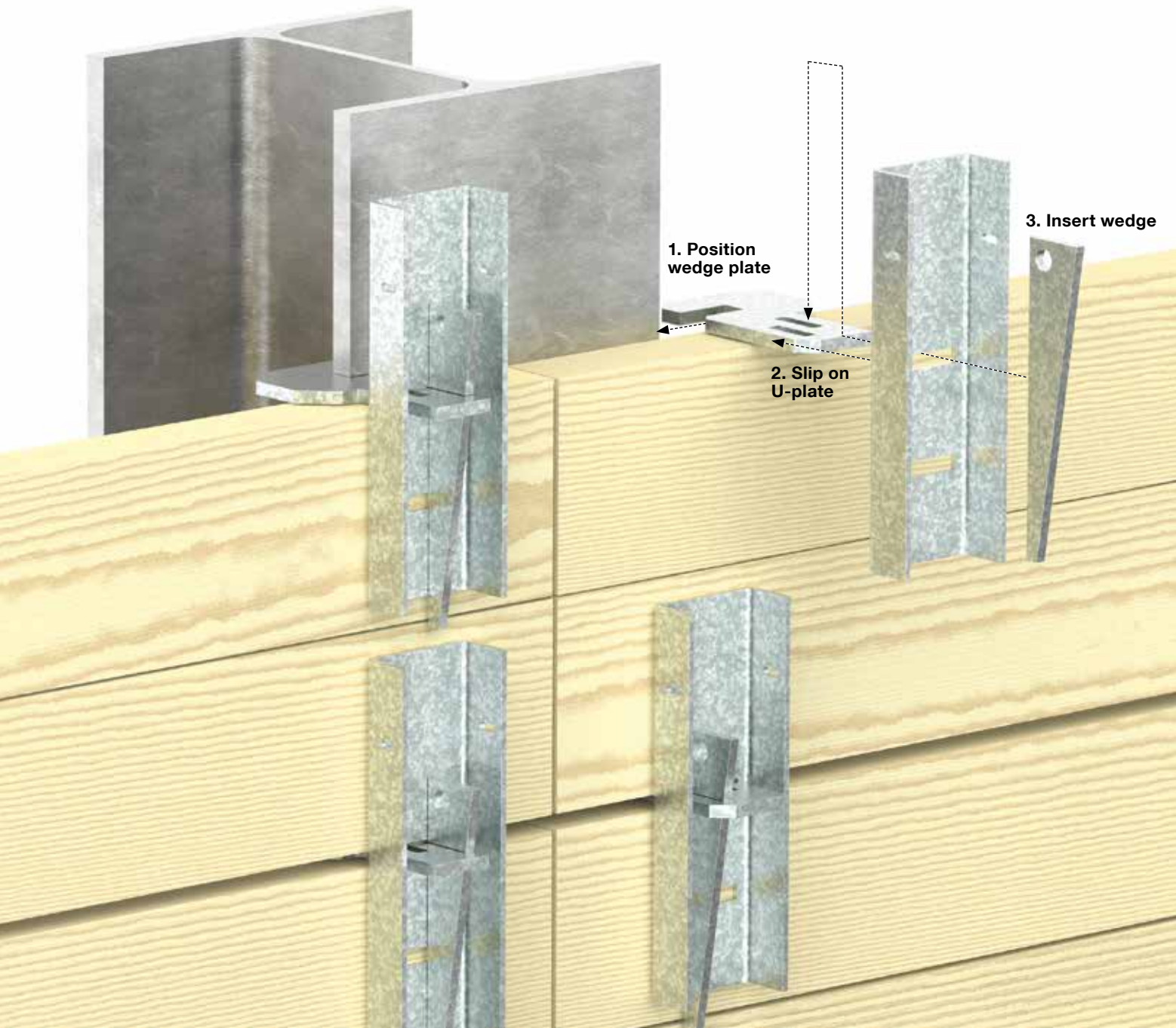



**Flexible combinations**

Various wedge plates are available for use with different soldier piles.

**Wedge plate for steel beams up to HEB 300**



**Wedge plate for steel beams up to HEB 800 or KD IV-6 trench sheeting (not illustrated)**



**Wedge plate for KD IV-6, KL 3-8 and KD VI-8 trench sheeting or steel beams up to HEB 900**



**Much less work required**

Fixing the planks to the front of the soldier piles considerably reduces the amount of work required. In particular, the complicated excavation between the piles is no longer necessary.

**Traditional soldier pile wall**

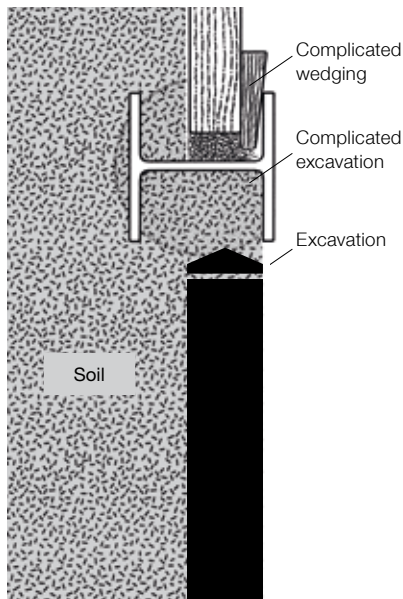

**Shoring with timber wedge clamps**

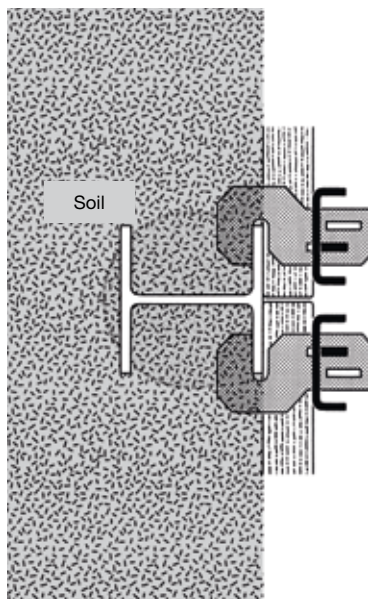

**Wide range of applications**

Ideal for inner-city excavations as deep as 7 m. With and without walings, secured with anchors or trench struts.



# Timber wedge clamp wall without tie back



Timber wedge clamp walls without walings are possible for excavations as deep as approx. 4 m. The table below can be used for preliminary design purposes. The assumptions must be checked for each specific application. It may be possible to use thinner planks when the soldier piles are closer together.

## Excavation shoring without anchors

- with timber sheeting and timber wedge clamps

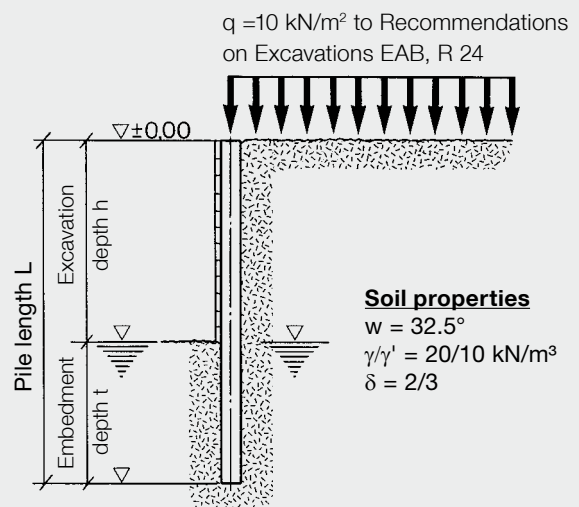
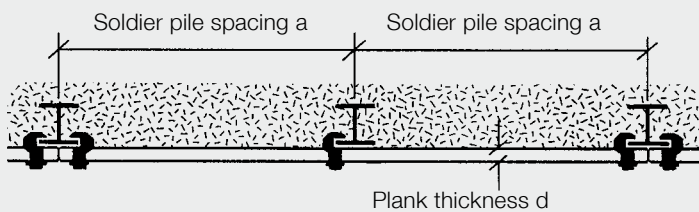

### Design example

Excavation depth h [m]	Soldier pile spacing a [m]	Beam S 235 [ - ]	Pile length L [m]	Embedment depth t [m]	Plank thickness d [mm]
2.0	2.5	HEB 200	6.0	4.0	80
2.5	2.5	HEB 240	7.1	4.6	80
3.0	2.0	HEB 260	8.0	5.0	80
3.5	2.0	HEB 300	9.0	5.5	80
4.0	2.0	HEB 340	10.0	6.0	80

Calculation to DIN 1054:2005; verification of ultimate limit state LS 1B, load case 2; earth pressure coefficients to DIN 4085:2007 and Recommendations on Excavations EAB, 2006



Tie backing the top of the soldier piles will be necessary for excavations deeper than 4 m or for larger spacings between the piles. TITAN micropiles, for instance, can be used for tie backing. The table below can be used for preliminary design purposes. The assumptions must be checked for each specific application. Please refer to the TITAN micropile brochure for more information.



## Excavation shoring with anchors

- with timber sheeting and timber wedge clamps

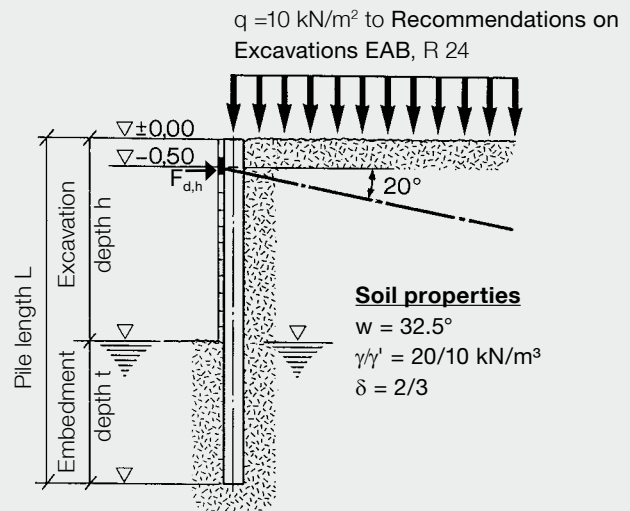
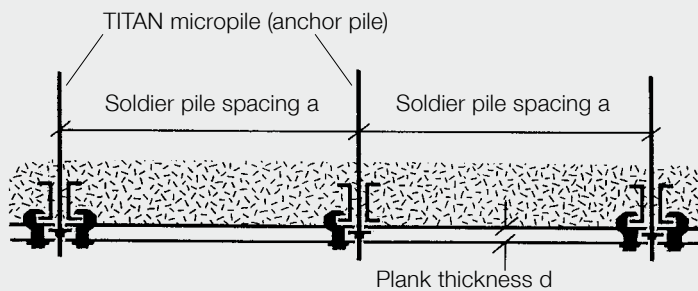

## Design example

Excavation depth h [m]	Soldier pile spacing a [m]	Beam S 235 [-]	Pile length L [m]	Embedment depth t [m]	Plank thickness d [mm]	Anchor force $F_{d,h}$ horizontal [kN]	Length of micropile* [m]
3.0	3.0	UU 200	4.3	1.3	100	81.0	5.0
3.5	3.0	UU 200	5.0	1.5	100	105.0	5.5
4.0	3.0	UU 220	5.7	1.7	100	130.5	6.1
4.5	3.0	UU 260	6.3	1.8	100	159.0	6.8
5.0	2.5	UU 280	7.0	2.0	100	157.5	7.3
5.5	2.2	UU 300	7.6	2.1	100	163.9	8.0
6.0	2.0	UU 320	8.2	2.2	80	173.0	8.6
6.5	1.8	UU 320	9.0	2.5	80	180.0	9.3
7.0	1.5	UU 320	9.6	2.6	80	171.0	10.0

\* to intersection with lower failure plane, without projection for pile head detail, length of grout body must be calculated

# Timber wedge clamp wall with walings and trench struts

Deep excavations in inner-city areas can lead to problems when anchors cannot be installed (e.g. next to buildings). In these situations the walings can be supported by trench struts, for example.



## Quick, safe waling installation

The self-centering hook ensures that waling and trench strut axes coincide. Misalignment of the strut is prevented and a concentric load transfer is guaranteed.

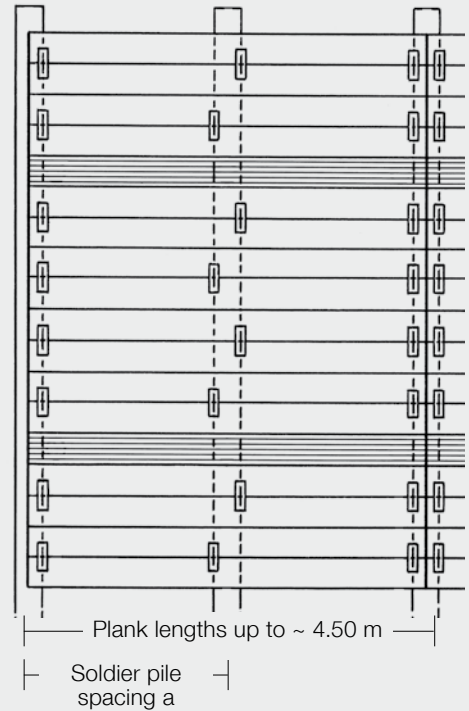
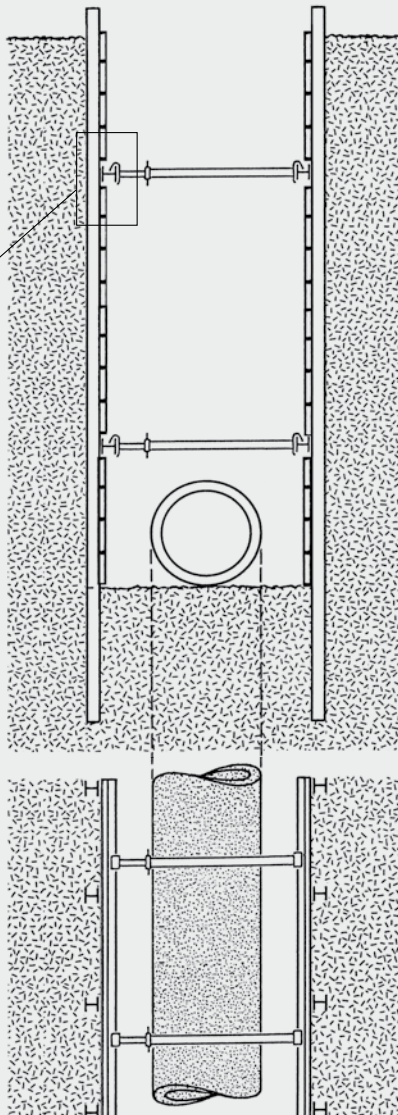
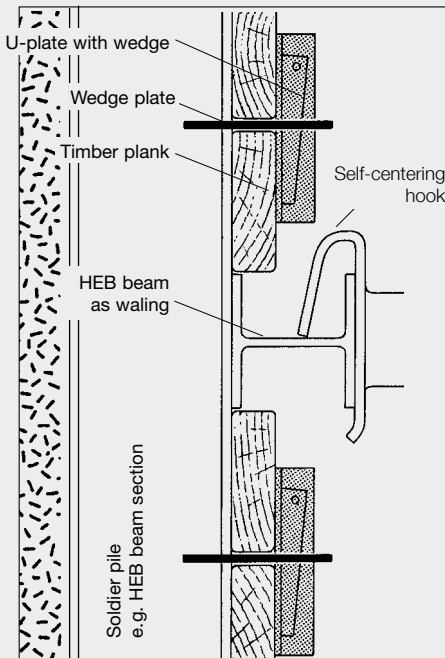

## Number of timber wedge clamps required

The number of timber wedge clamps required can vary depending on the spacing of the soldier piles. The following values can be used as a guide for normal situations:

Soldier pile spacing a	Number of timber wedge clamps
2.25 m	1.4 pcs./m <sup>2</sup>
2.50 m	1.8–2 pcs./m <sup>2</sup>





**GIGANT SV trench struts** with TBG 3 - Gi - SV certification to DIN 4124, with self-centering hook for HEB 140–300 steel beam walings

Designation	Range of adjustment	Perm. load	Weight	Part No.
Gi-SV-210	1.40 – 2.10 m	548 – 290 kN	69 kg	0230200006
Gi-SV-260	1.90 – 2.60 m	471 – 260 kN	81 kg	0230200007
Gi-SV-310	2.40 – 3.10 m	424 – 270 kN	92 kg	0230200008
Gi-SV-380	3.10 – 3.80 m	390 – 258 kN	107 kg	0230200009
Gi-SV-450	3.80 – 4.50 m	344 – 262 kN	122 kg	0230200010
Gi-SV strut spanner			3.70 kg	0630200026



**GIGANT S trench struts** with TBG 3 - Gi - S certification to DIN 4124, with self-centering hook for HEB 140–300 steel beam walings

Designation	Range of adjustment	Perm. load	Weight	Part No.
Gi-S-120	0.70 – 1.20 m	210 – 177 kN	26 kg	0230200020
Gi-S-170	1.05 – 1.70 m	210 – 177 kN	32 kg	0130200001
Gi-S-210	1.40 – 2.10 m	184 – 156 kN	35 kg	0130200002
Gi-S-260	1.90 – 2.60 m	176 – 140 kN	40 kg	0130200003
Gi-S-310	2.40 – 3.10 m	157 – 138 kN	45 kg	0130200004
Gi-S strut spanner			3.20 kg	0620220030



**Gi-SV-I spindle and fixed heads** with TBG 3 - Gi - SV - I certification, with self-centering hook for steel beam walings up to HEB 300. For bolting (M16) or welding to the webs of HEB 140–200 steel beams.

Designation	Range of adjustment	Perm. load	Weight	Part No.
Gi-SV-I	0.72 – 0.97 m	448 – 393 kN	50 kg	0130220010
Gi/T/F	-	448 – 393 kN	6.2 kg	0130220007



**Tested and approved by the civil engineering employers' liability insurance association (TBG)**

**Timber wedge clamp, complete**

for connecting to steel beams and trench sheeting, perm. load 30 kN, consisting of

- U-plate 100 x 300 mm with 2 slots
- wedge
- wedge plate

①, ② or ③



with wedge plate ①  
galvanised,  
Weight 3.25 kg  
Part No. 0130604501



with wedge plate ②  
galvanised,  
Weight 3.4 kg  
Part No. 0130604503



with wedge plate ③  
galvanised,  
Weight 3.62 kg  
Part No. 0130604502



**U-plate**

galvanised,  
Weight 1.86 kg  
Part No. 0130600015



**Wedge**

galvanised,  
Weight 0.44 kg  
Part No. 0130600011



**Wedge plate ①**

galvanised  
Weight 0.94 kg  
Part No. 0130600012

up to HEB 180  
45 – 90 mm plank thickness  
up to HEB 300  
40 – 85 mm plank thickness



**Wedge plate ②**

galvanised,  
Weight 1.09 kg  
Part No. 0130600014

up to HEB 180  
55 – 155 mm plank thickness  
up to HEB 300  
50 – 150 mm plank thickness  
up to HEB 400  
45 – 145 mm plank thickness  
up to HEB 800  
40 – 135 mm plank thickness  
KD IV-6 trench sheeting  
50–140 mm plank thickness



**Wedge plate ③**

galvanised,  
Weight 1.31 kg  
Part No. 0130600013

KD IV-6  
100 – 115 mm and 135 – 150 mm plank thickness  
KL 3-8  
85 – 100 mm and 120 – 135 mm plank thickness  
KD 6-8  
66 – 93 mm and 101 – 128 mm plank thickness  
Steel beams  
up to HEB 900

**Timber specification** to DIN 4124:2012, section 6.1.5, for horizontal installation in trench shoring:

- at least grade S10 to DIN 4047-1
- at least 50 mm thick (for excavation depths > 1.25 m)

The photos reproduced in this brochure represent momentary snapshots of work on building sites. It is therefore possible that certain facts and circumstances do not fully correspond to the technical (safety) requirements.



Falsework and Formwork systems



Trench lining systems



Geotechnical solutions

Certified Management-System to DIN EN ISO 9001 / 2008 ; Registry-No. DE-96-010



**FRIEDR. ISCHEBECK GMBH**

Managing Directors: Dipl.-Wi.-Ing. Björn Ischebeck, Dr. jur. Lars Ischebeck  
Loher Str. 31-79 | 58256 Ennepetal | Germany | Tel. +49 (2333) 8305-0 | Fax +49 (2333) 8305-55  
E-mail: export@ischebeck.de | http://www.ischebeck.de